



**BRAND**  
**HYDRAULICS Co.**

Made in the Heartland of America  
Serving the World

Engineering & Manufacturing Solutions

# LS

4-Way Directional Control Valve  
With Hydraulic Kick Out

## Specifications:

- Rated for 0-18 gpm (0-68.1 lpm)
- Rated for 3000 psi (207 bar)
- Weighs 5-1/2 lbs. (2.5 kg)
- 30 – Micron filtration recommended



PLS755T4JRSH



ISO 9001:2008 WITH DESIGN  
Certificate #02.002.1



402.344.4434 • [www.brand-hyd.com](http://www.brand-hyd.com)

LS755T4JRSH

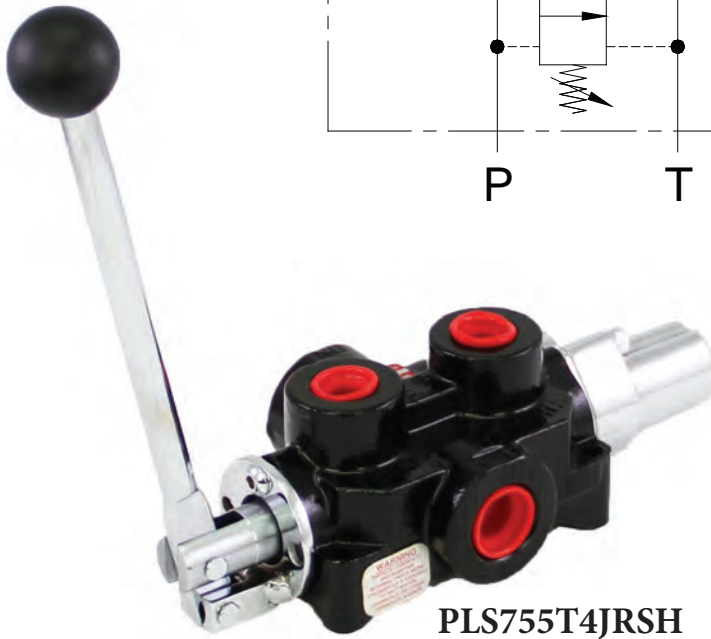
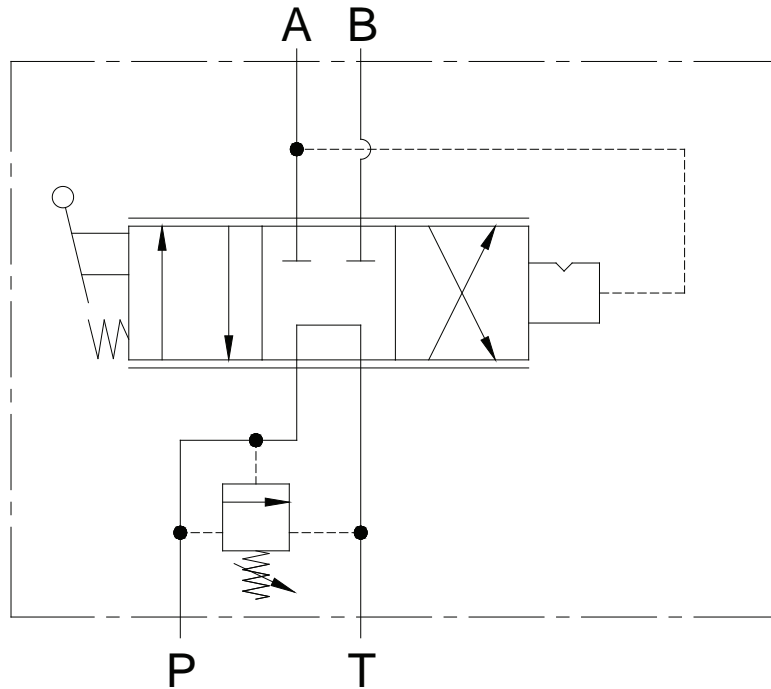

PLS755T4JRSH

**MATERIALS:**

- Cast Iron Body
- Buna N O'Rings
- IOSSO Plated Steel Spool
- Black Nylon Ball Knob

**FEATURES:**

- SINGLE ADJUSTABLE HYDRAULIC KICK OUT.
- OPTIONAL DOUBLE HYDRAULIC KICK OUT is not recommended for log splitters.
- SMALL AND COMPACT to fit your design requirements.
- FINE POSITIVE METERING in either direction with the manually adjustable handle.
- PRECISION GROUND IOSSO PLATED SPOOL that assures long life.

## LS – GENERAL INFORMATION:

The Brand, LS 4-way directional control valve is designed primarily for log splitters. The manual adjustable handle provides fine metering to either port. Port flow is directly proportional to the movement of the lever. The tank port must be plumbed directly back to tank.

**SPOOL TYPE** – The spool types offered are tandem center 4-way (**T4**), open center 4-way (**O4**), closed center 4-way (**C4**). (See chart and schematics for information on spool types).

## HANDLE OPTIONS –

- **Lever handle (J)** pressurizes A port when the handle is pushed towards the valve body (clevis below spool).
- **Lever handle (L)** pressurizes A port when the handle is pulled away from valve body (clevis above spool).
- **No actuator (M)** J type spool.

## SPOOL ACTION –

- **Spring center hydraulic detent (SH)** springs back to neutral from one position and pressure release detent in the other direction when the cylinder completes its return stroke (P to A in detent and 800-1000 psi (55 to 69 bar) kick-out setting).
- **Single hydraulic kick-out (SH)** preset at 800 PSI. Adjustable from 800 to 2200 PSI.
- **Hydraulic detent in both directions (HHA)** pressure release detent in both directions and springs to center when out of detent (Not recommended for log splitters).
- **Adjustable relief (R)** set to 2000 psi (138 bar) at factory.

### SPOOL SCHEMATICS:

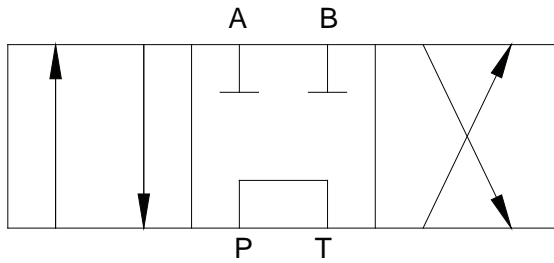

**Tandem Center 4-Way (T4)** - Powers cylinder or motor in both directions. Pump unloads to tank when spool is in neutral. Cylinder or motor blocked when spool in neutral.

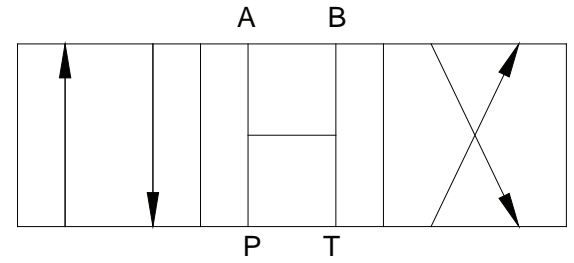

**Open Center 4-Way (O4)** - All of the ports are connected to tank when the spool is in neutral. Allows cylinder to move or motor to rotate when spool is in neutral.

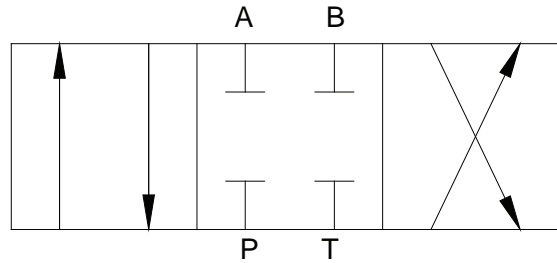

**Closed Center 4-Way (C4)** - All ports are blocked in neutral. Blocks cylinder or motor in neutral. Required for use with pressure compensated pump.

**LS – CREATING A MODEL CODE FOR LS'S:**

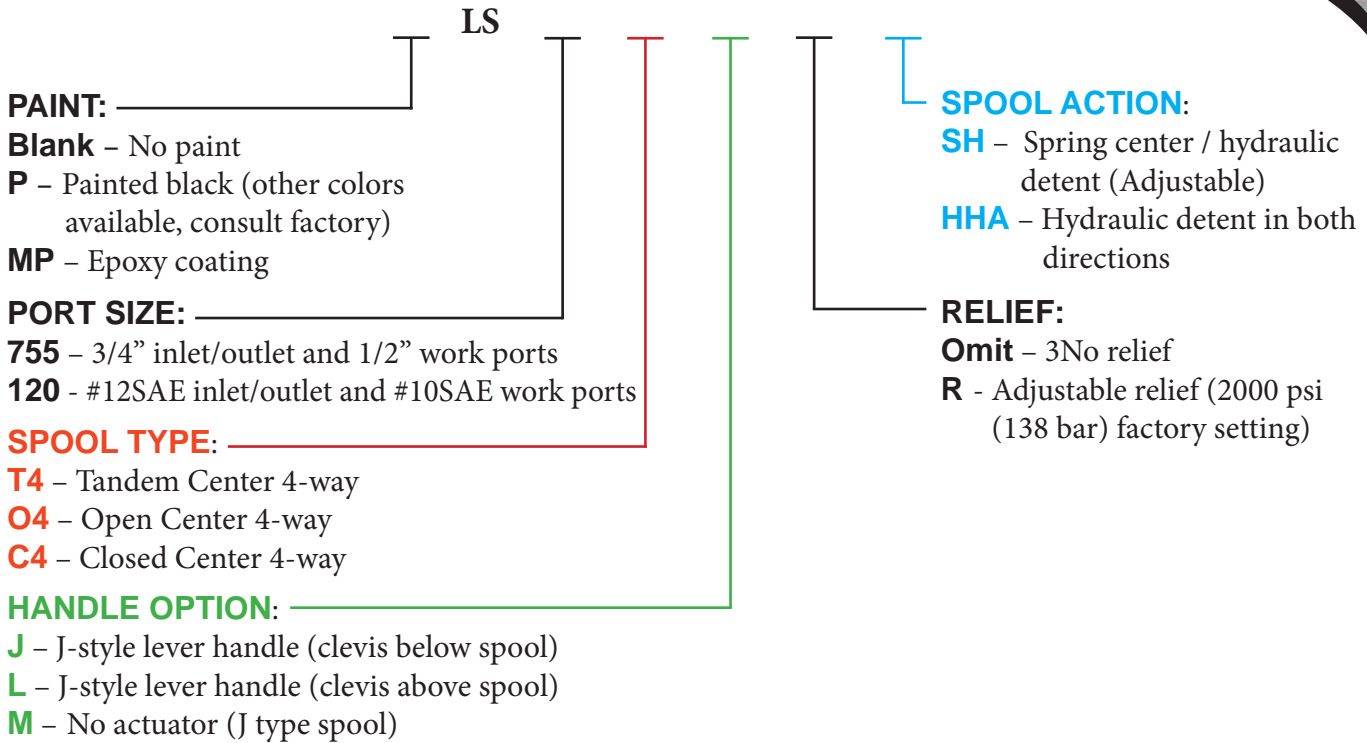

**LS – EXAMPLES OF COMMON MODEL CODES:**

**LS755C4JRS**H.....3/4" NPT inlet/outlet, 1/2" NPT work ports, closed center 4-way spool, J-style actuator, adjustable relief set at 2000 psi (138 bar), and spring center one direction hydraulic detent in other direction with non-adjustable kick-out.

**LS755T4JRHHA**.....3/4" NPT inlet/outlet, 1/2" NPT work ports, tandem center 4-way spool, J-style actuator, adjustable relief set at 2000 psi (138 bar), and hydraulic detent in both directions.

**LS – COMPLETE LIST OF OPTIONS AND ACCESSORIES:**

- LSJRHH-K**..... Seal kit for LS with HHA spool action.
- LSJRS-K**..... Seal kit for LS with SH spool action.
- LS-RK**..... Kick-out assembly with spool for SH spool action.

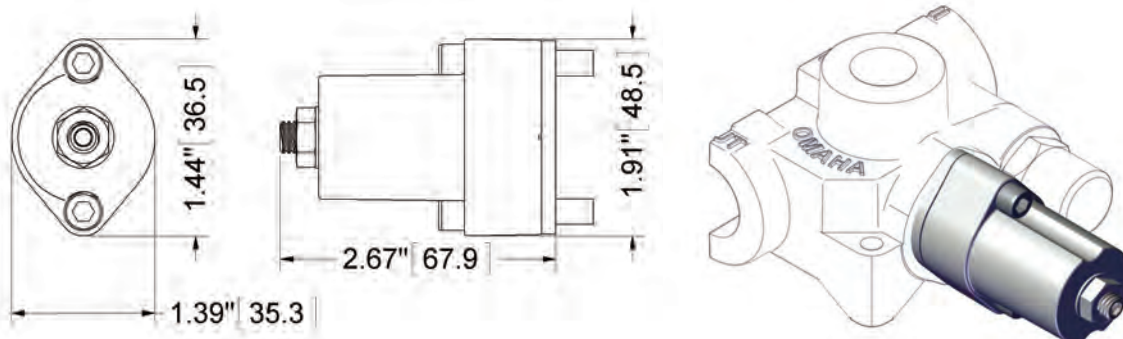

## LS - FLOW AND PRESSURE INFO:

Pressure Drop VS. Flow

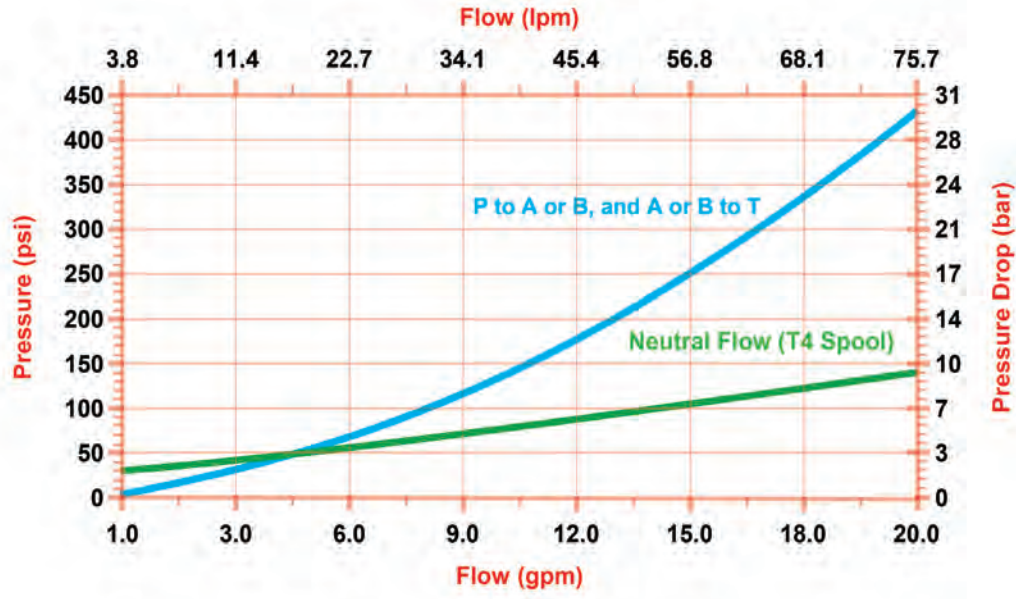

Pressure VS. Flow for LS Relief (R)

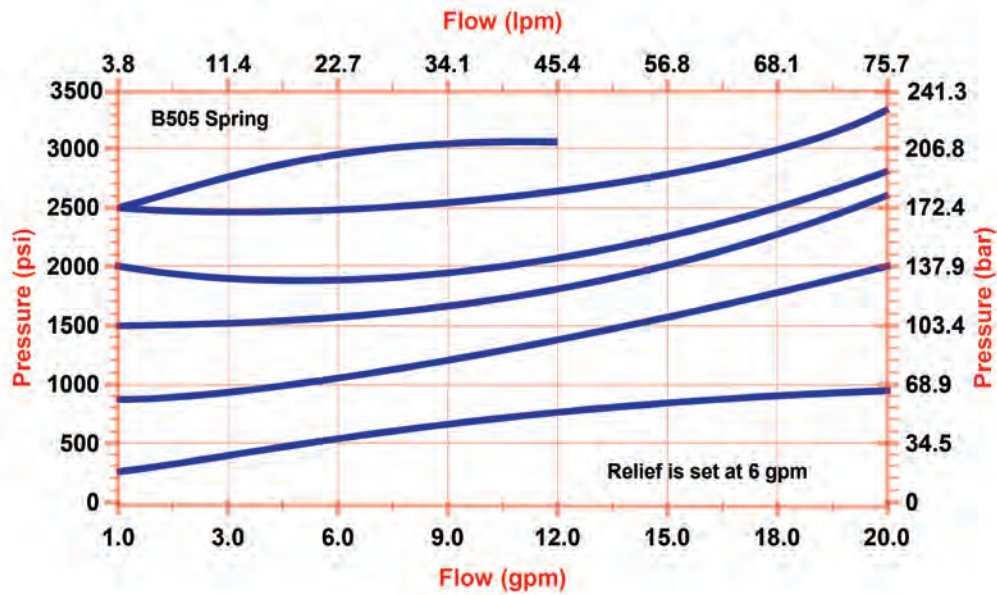

**DIMENSIONAL DATA (LS755T4JRSH SHOWN): inches & [millimeters]**

