

## DC DIRECTIONAL CONTROL VALVE INSTALLATION & USER GUIDE

### SPECIFICATIONS:

- Rated for 0-45 gpm (0-170 lpm).
- Rated for 3000 psi (207 bar).
- Std. port sizes (Consult factory for others).
- 3/4" NPT all ports.
- #16 SAE (1-5/16-12) all ports.
- Weighs 16 lbs. (7.3 kg).
- 20 – Micron filtration recommended.

### MOUNTING, ADJUSTMENT & ASSEMBLY INSTRUCTIONS:

- **Mounting** – Valve can be mounted in any orientation. Valve must be mounted on a flat surface. Special attention should be paid to not bend or twist the casting when mounting. Doing so may cause the valve to fail.
- **Relief Adjustment** – Relief setting is factory preset to 1500 psi, unless otherwise noted within model code. Relief valve can be set anywhere within the range of 500 psi to 3000psi.  
**To adjust relief pressure:** First, remove chrome hex plug above with a 7/8" combination wrench, and set aside. You will then have access to the relief set screw (5/16" hex). Turning this screw clockwise 1 turn will increase pressure approximately 800psi.
- **Handle Assembly** – To install handle, place the ball end of the handle in the spool and then join handle and the retainer using the supplied pin.
  - Regardless of handle style, the handle retainer will be installed on valve from factory. Unless specified, the clevis's placement is defaulted so the handle points up when the valve is placed on a flat surface. To change this, prior to handle installation, the screws holding the retainer/clevis must be removed and the clevis can then be rotated 180° around the spool.

### FREQUENTLY ASKED QUESTIONS:

**Q:** Can I plumb another valve downstream from this valve, using the outlet of this valve?

**A:** No. The outlet of this valve should be plumbed back to tank.

**Q:** What kits are available for this valve?

**A:** There is a replacement seal kit (Part #: DC-K), and replacement relief kit (Part #: TS-B) for this valve. There are also a number of different kits available for this valve depending on the spool action, and handle option the valve is equipped with. Please contact factory for specific kit numbers relating to different spool actions, and handle options.

**Q:** Can I paint the valve?

**A:** Painting valves is acceptable as long as the following precautions are taken:

- 1- All ports must be plugged
- 2- Spool must be masked or taped off completely.

Any paint on the spool will cause leakage when it chips off. Warranty is void if any valve is returned with paint on the spool.

### GENERAL INFORMATION:

**Pipe Thread Sealant** - Warranty is void when Teflon tape is used to seal pipe threads. This is because Teflon tape is a friction reducing agent which allows customers to over-torque fittings. We recommend using a sealant that does not include friction reducing agents i.e. Lead Plate.

**Spool Information** - All DC's are built with Iosso plated spools to improve wear and corrosion resistance. For highly corrosive environments, i.e. marine applications, we recommend using a stainless steel spool. To order a valve with a stainless steel spool simply add "SS" to the end of the model code.

### DIMENSIONAL DATA:

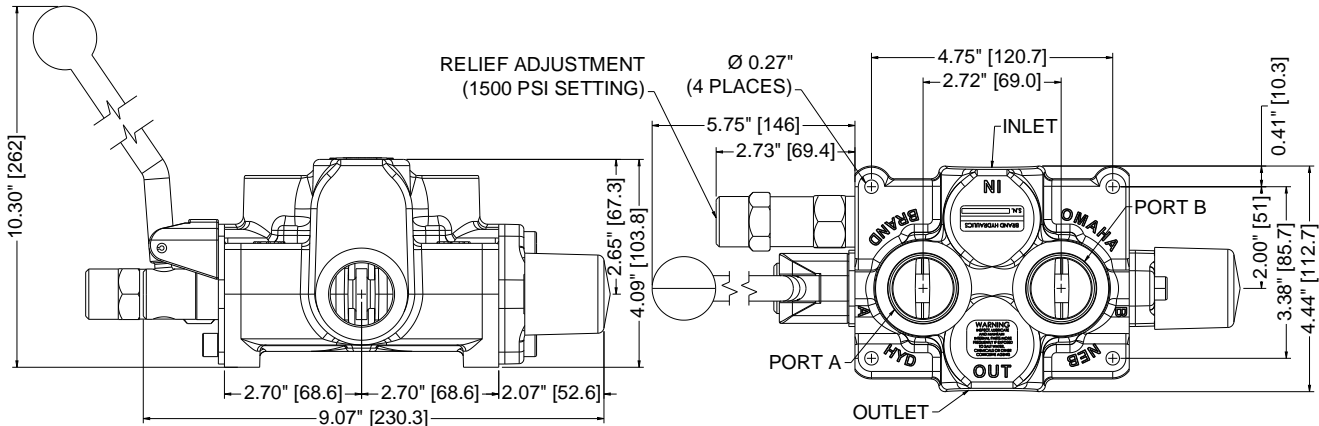

### FLOW & PRESSURE INFORMATION:

Pressure vs. Flow for B Relief (DC)

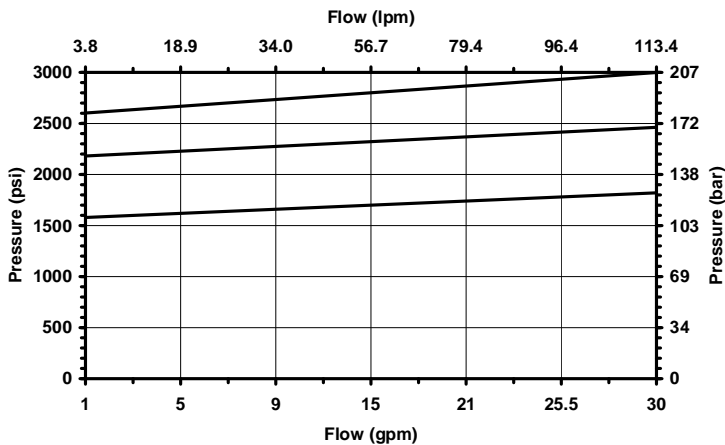

Neutral Flow Pressure Drop

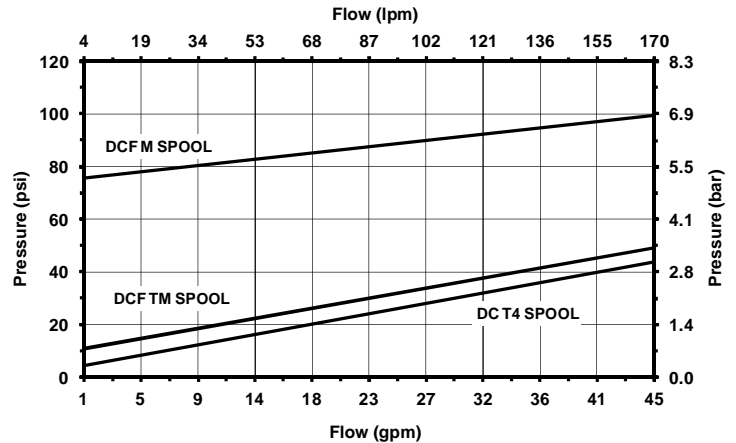

### SPOOL SCHEMATICS:

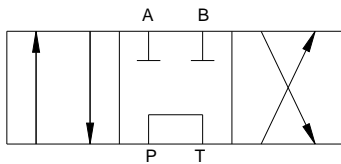

Tandem Center (T) - Powers cylinder or motor in both directions (metering capability is very limited). Pump unloads to tank when spool is in neutral. Cylinder or motor blocked when spool in neutral. This spool is not designed for DCF valve.

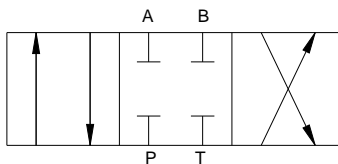

Closed Center (C) - All ports are blocked in neutral. Blocks cylinder or motor in neutral. Required for use with pressure compensated pump. This is not available for DCF valve.

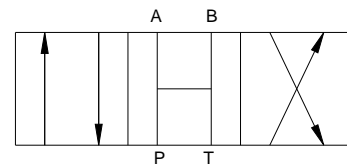

Open Center (O) - All of the ports are connected to tank when the spool is in neutral. Allows cylinder to move or motor to rotate when spool is in neutral. This spool is not designed for DCF valve.

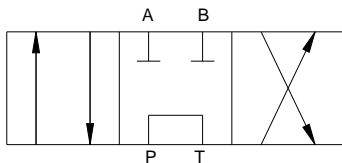

Tandem Metering Spool (TM) - Similar to (T) spool except much finer metering control. The pressure drop in neutral is lower than the (M) spool. Cylinder or motor blocked in neutral and pump unloads to tank. This spool is designed for DCF valve.

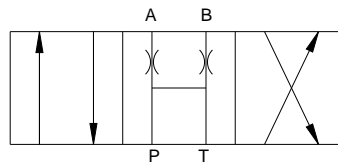

Fine Metering Spool (M) - The pressure drop in neutral is higher than the (TM) spool. Requires external locking valves to hold cylinder, because ports A and B are open (orificed) in the neutral position. Extremely fine metering control. This spool is designed for the DCF valve and acts as closed center in DC valve.

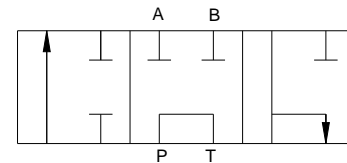

Tandem Three Way (T3) - Powers the cylinder in one direction. Pump unloads to tank when spool is in neutral, or when spool is being reversed. Cylinder is blocked when spool is in neutral. Port "B" is plugged. This spool is designed for the DC valve.



## **SAFETY PRECAUTIONS:**

- It is the purchaser's responsibility to determine the suitability of any Brand Hydraulics Co. product for an intended application, and to ensure that it is installed in accordance with all federal, state, local, private safety and health regulations, codes and standards. Due to the unlimited variety of machines, vehicles and equipment on which our products can be used, it is impossible for Brand Hydraulics Co. to offer expert advice on the suitability of a product for a specific application. It is our customer's responsibility to undertake the appropriate precautions, testing and evaluation to prevent injury to the end-user.
- Overpressure may cause sudden and unexpected failure of a component in the hydraulic system, resulting in serious personal injury or death. Always use a gauge when adjusting a relief valve.